

# TOMMY MINITOMMY

FLOODLIGHT

MODEL:	
Minitommy	Minitommy 2L
Minitommy-EL	Minitommy-EL 2L
Tommy	Tommy 2L
Tommy-EL	Tommy-EL 2L
Tommy-SQ	Tommy-SQ 2L

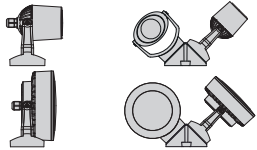

**UK CAUTION!** Installation and maintenance procedures must be carried out only after switching off the electricity supply. Use energy saving lamps only. Fit the gasket properly inside the fitting, to ensure the IP protection. Fumagalli Srl accepts no responsibility whatsoever for damages caused by incorrect installation, misuse or when used by combining it with spare parts not belonging to the products. If in doubt, consult a qualified electrician. Keep the instructions.

**I ATTENZIONE!** L'installazione e la manutenzione dell'apparecchio devono essere eseguite solo dopo aver disinserito l'energia elettrica. Utilizzare solo lampade a basso consumo. Assicurarsi del corretto posizionamento della guarnizione all'interno dell'apparecchio al fine di garantire il grado di protezione IP. Fumagalli Srl non accetta responsabilità per danni causati da incorretta installazione, incorretto uso o dall'utilizzo di parti di ricambio che non appartengono al prodotto originale. Per qualsiasi dubbio, consultare un elettricista qualificato. Conservare le istruzioni.

**F ATTENTION!** Les opérations de montage et d'entretien ne doivent être effectués que lorsque le courant électrique est coupé. Utiliser seulement des ampoules à économie d'énergie. Assurer le positionnement correct de le joint dans l'appareil, afin de garantir le degré de protection IP. Fumagalli Srl n'accepte pas aucune responsabilité pour toutes les dommages causés par une mauvaise installation, par un utilisation incorrecte or par l'utilisation des pièces de rechange qui ne sont pas originales. En cas de doutes, faites appel à un électricien qualifié. Conserver les instructions.

**E PRECAUCIÓN!** Lleve a cabo la instalación y mantenimiento tras cortar la tensión de la instalación eléctrica. Use únicamente lámparas de bajo consumo. Ajuste correctamente el aro de goma con el producto para asegurar la protección IP indicada en el producto. En cualquier caso Fumagalli Srl no aceptará responsabilidad alguna por instalación incorrecta, mal uso o por su uso con accesorios no originales del fabricante. En caso de duda consulte con un electricista cualificado. Guarde estas instrucciones.

[WARRANTY] Fumagalli products are CE marked. Declaration CE of conformity available at [www.fumagalli.it/company](http://www.fumagalli.it/company). The warranty of Fumagalli product is of 1 year. In case of evident manufacturing faults, Fumagalli Srl according to his unquestionable judgement, will proceed to the repair or the replacement. This warranty does not cover any cost neither regarding the transport, nor the uninstallation, nor the re-installation, nor the dismantlement of the material.

[GARANZIA] I prodotti Fumagalli sono marchiati CE. La Dichiarazione CE di conformità è disponibile su [www.fumagalli.it/company](http://www.fumagalli.it/company). I prodotti Fumagalli godono di una garanzia di legge di 1 anno. Nel caso di evidenti difetti di fabbricazione Fumagalli Srl, a suo insindacabile giudizio, procederà alla sua riparazione o sostituzione. In nessun caso l'acquirente potrà reclamare rimborsi o spese sostenute per l'installazione, la disinstallazione, il trasporto o lo smaltimento del materiale.

## MINITOMMY - TOMMY 1L

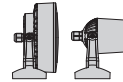

WALL / CEILING / GROUND

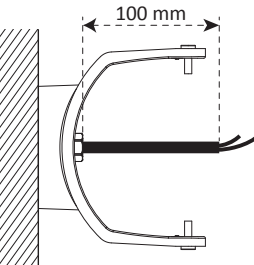
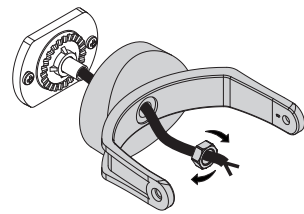
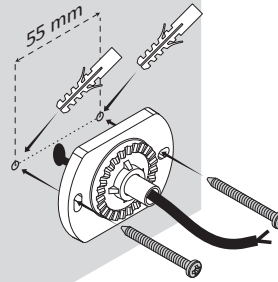
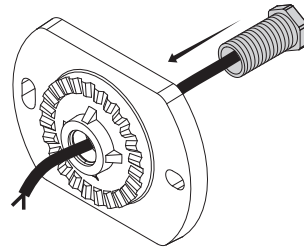

GROUND SPIKE

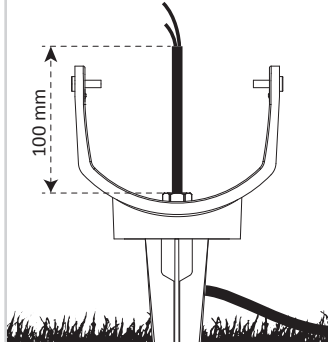
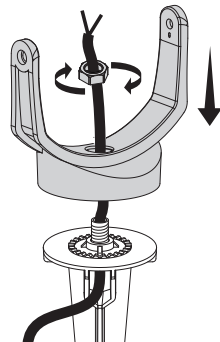
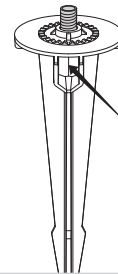
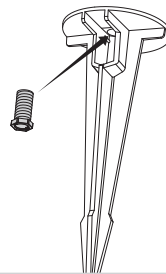

55mm



## MINITOMMY - TOMMY 2L

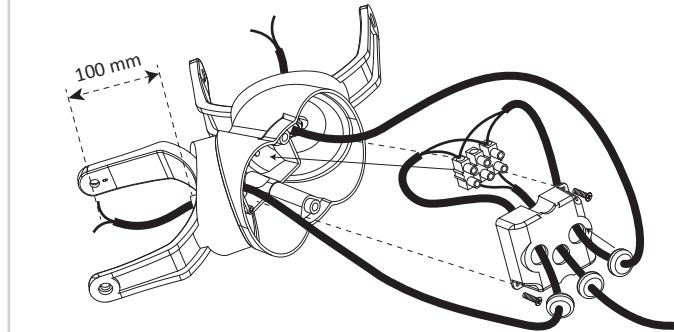
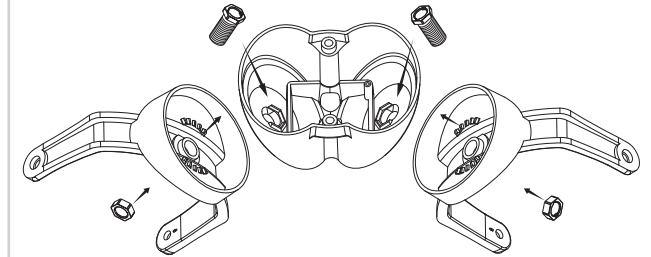

WALL / CEILING / GROUND

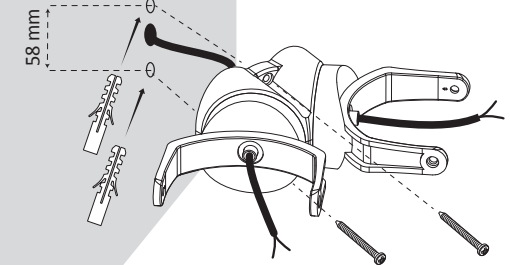

GROUND SPIKE

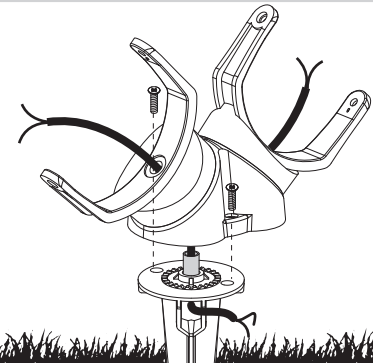

58mm



# MINITOMMY

GU10 LED

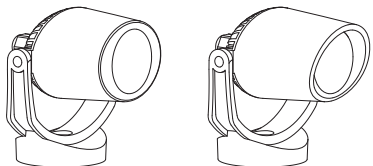

# MINITOMMY-EL

1

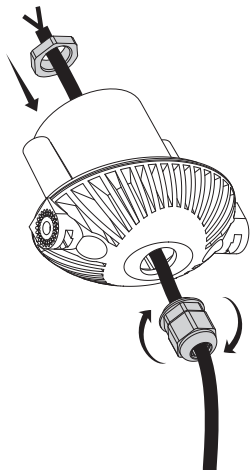

2

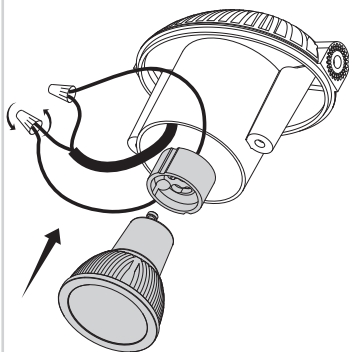

MAX 6 W  
MAX 250 V  
50/60 Hz

3

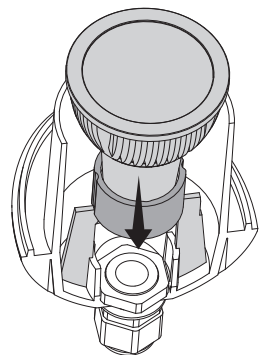

4

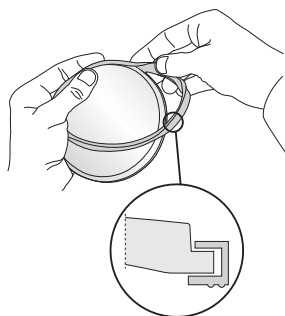

5

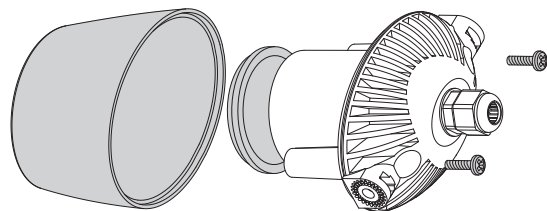

4

6 1L version

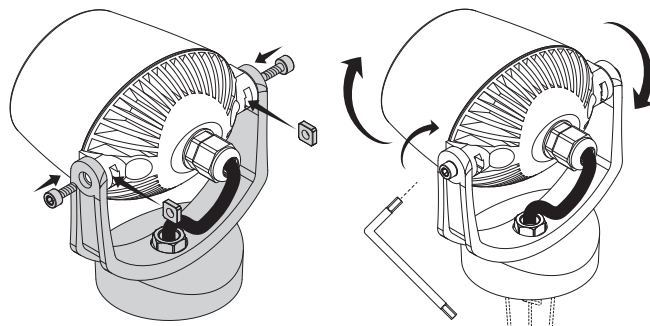

6 2L version

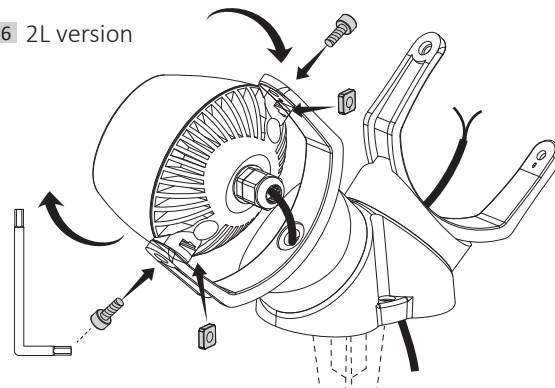

# TOMMY

# TOMMY-EL

# TOMMY-SQ

GX53 LED

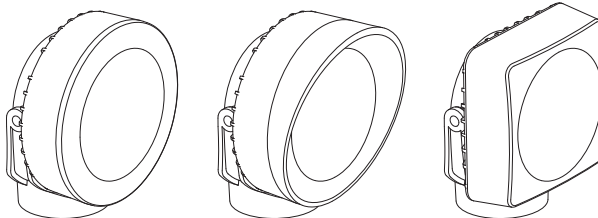

1

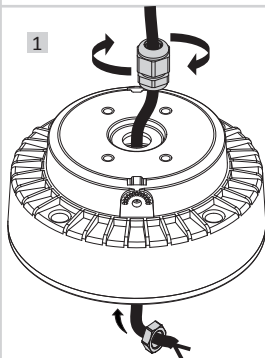

2

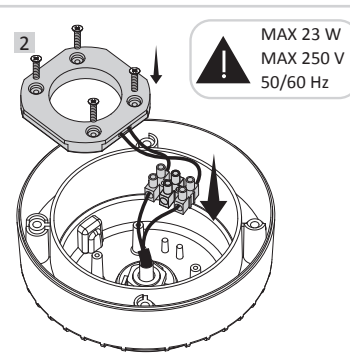

MAX 23 W  
MAX 250 V  
50/60 Hz

5

3

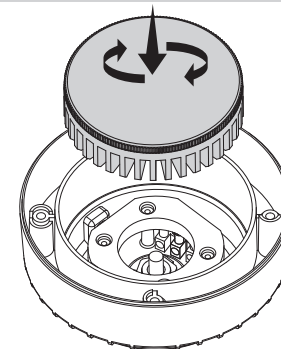

4

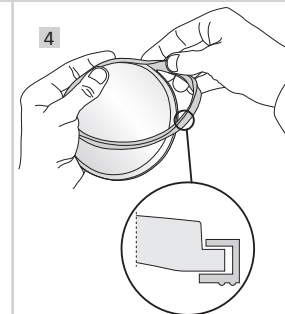

5

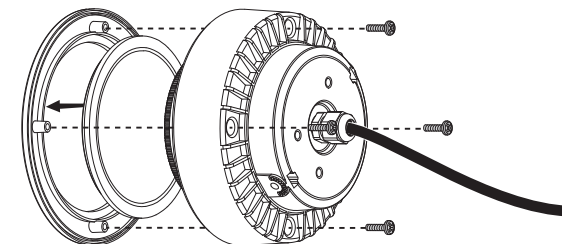

6 1L version

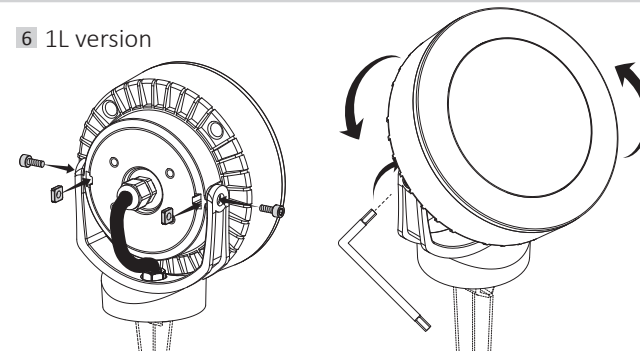

6 2L version

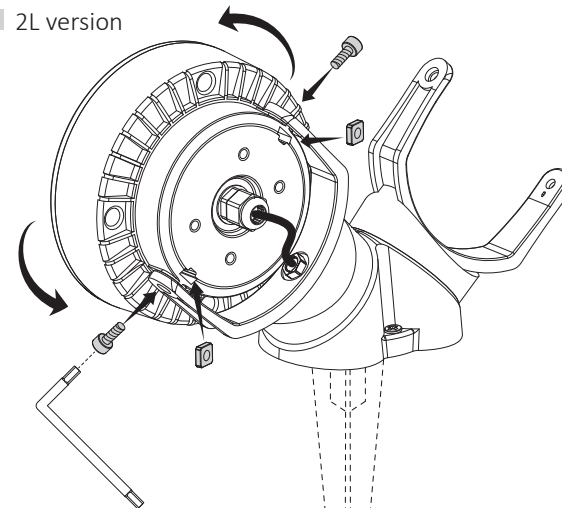

6